

# Operating Guide

## 1000 Series Dispensers

1000XL • 1000D

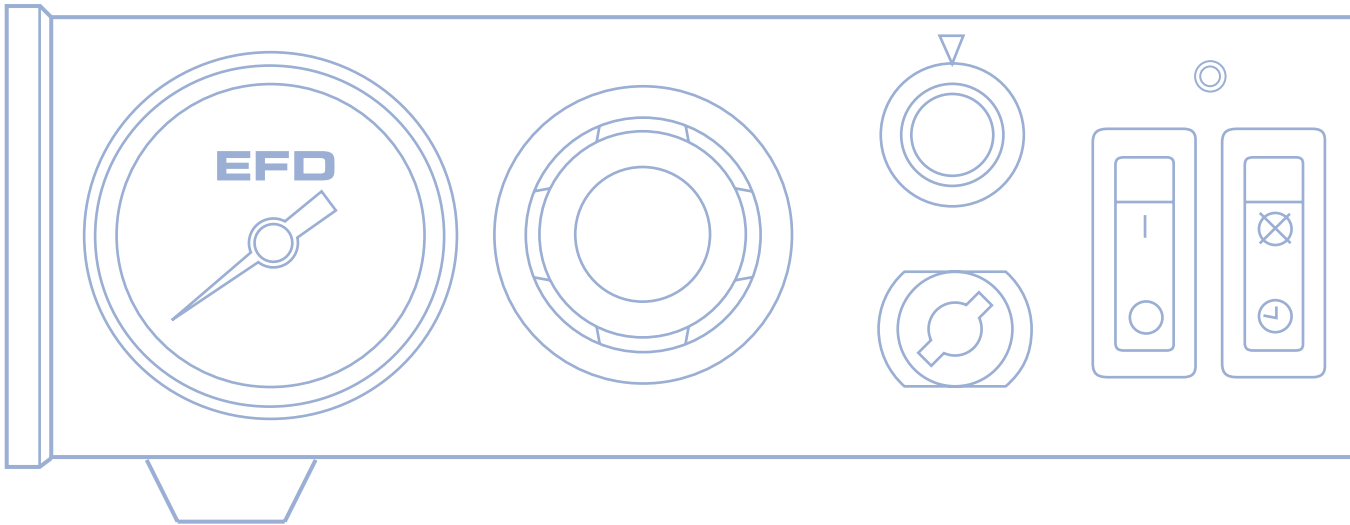

In the US: 800-556-3484    In the UK: 0800 585733    In Mexico: 001-800-556-3484

# Introduction

The 1000 Series dispensers provide years of trouble-free, productive service. This Operating Guide will help you maximize the usefulness of your new dispenser.

Please spend a few minutes to become familiar with the controls and features of your new dispenser. Follow our recommended testing procedures. Review the helpful information we have included based on over 30 years of industrial dispensing experience.

Most questions you will have are answered in this Guide. However, if you need assistance, please do not hesitate to contact EFD or your authorized EFD distributor.



**In the US, call 800-556-3484.**

In Mexico, call 001-800-556-3484.

In the UK, ring free 0800 585733.

## The EFD Pledge

We pledge that you will be completely satisfied with our products. We endeavor to ensure that every EFD product is produced to our no-compromise quality standards.

If you feel that you are not receiving all the support you require, or if you have any questions or comments, I invite you to write or call me personally.

Our goal is to build not only the finest equipment and components, but also to build long-term customer relationships founded on superb quality, service, value and trust. John Carter, President

# Contents

Getting Started .....	4
Specifications	
First Steps .....	5
Unpacking the Dispenser and Activating your Ten Year No-fault Warranty	
1000XL - Hookup .....	6-7
1000XL - Setup for Testing .....	8-9
1000D - Hookup .....	10-11
1000D - Setup for Testing .....	12-13
Testing the 1000 Series Dispensers .....	14-15
Making Timed Deposits	
Changing Deposit Size	
Drawing Stripes	
ULTRA Dispensing System .....	16-17
How to Use the Vacuum Control .....	18-19
1000XL only	
Loading the Barrel Reservoirs .....	20-21
Now, Test Your Fluid .....	22
Troubleshooting .....	23
1000XL and 1000D Schematic & Parts .....	24
1000 Series Programmable Timer .....	25
Suggestions & Reminders .....	26
Components Reorder .....	27
Ten Year No-fault Warranty .....	28

This manual is for the express and sole use of EFD dispenser purchasers and users, and no portion of this manual may be reproduced in any form.

EFD, ULTRA System, LV Barrier, SmoothFlow, ZeroDraft, SafetyLok, SnapLok and DispenStand are trademarks of EFD Inc. ©2004 EFD Inc.

*Meets applicable CSA and CE requirements.*

Reference CSA LR File Number 84105

# Getting Started

We have organized this Guide to provide setup and testing procedures for the 1000XL and 1000D dispensers.

If you have the 1000XL, first review pages 6 - 9 which illustrate how to hook up the dispenser and what the controls do.

For the 1000D, review pages 10 - 13.

Next, pages 14 - 15 show how to dispense the thick, paste-like test material included in the Test Kit. These instructions are common to both 1000 Series dispensers.

Finally, pages 18 - 19 illustrate how to dispense low-viscosity liquid using the vacuum control provided on the 1000XL.

The rest of the information in this Guide applies to both of the 1000 Series dispensers.

## 1000 Series Specifications

Input voltage: Selectable  
100/120/220 VAC  
50/60 Hz 16/13 VA

Internal voltage: 24 VDC

Foot-pedal voltage: 9 VDC

Air input: 80 to 100 psi  
(5.5 to 6.9 bar)

Air output: 0 to 100 psi  
(0 to 6.9 bar)

Cycle rate: > 600/minute

Time repeat:  $\pm 0.1\%$

Initiation: maintained or momentary

Time Range: programmable (seconds)  
0.005 to 0.04 sec.  
0.01 to 1.0 sec.  
0.1 to 10 sec.  
0.2 to 20 sec.  
0.3 to 31 sec.

### 1000XL

10 $\frac{3}{8}$  x 8 $\frac{1}{2}$  x 2 $\frac{5}{8}$ "      5 lb 12 oz  
26.4 x 21.6 x 6.7 cm      2.63 kg

### 1000D

8 $\frac{5}{8}$  x 8 $\frac{1}{2}$  x 2 $\frac{5}{8}$ "      4 lb 12 oz  
21.9 x 21.6 x 6.7 cm      2.18 kg

# First Steps

First: Unpack and use the checklist enclosed with the Dispenser Kit to identify all items. If there is any discrepancy, please call us immediately.

Second: Power and compressed plant air should be available where the dispenser is to be set up. Air pressure should be between 80 and 100 psi (5.5 to 6.9 bar). (Bottled nitrogen can be used.) If you are not using an EFD five-micron filter regulator #2000F755, **be certain your plant air is properly filtered and dry.**

[Check voltage label to be certain it agrees with the available power.](#)

Third: Now is a good time to ACTIVATE your extended Ten Year No-fault Warranty. Please fill in and return the postage-paid Warranty card. Or, if you prefer, call the appropriate toll-free number listed below, provide the serial number of your dispenser and respond to a few short questions.



**In the US, call 800-556-3484.**

In Mexico, call 001-800-556-3484.

In the UK, ring free 0800 585733.

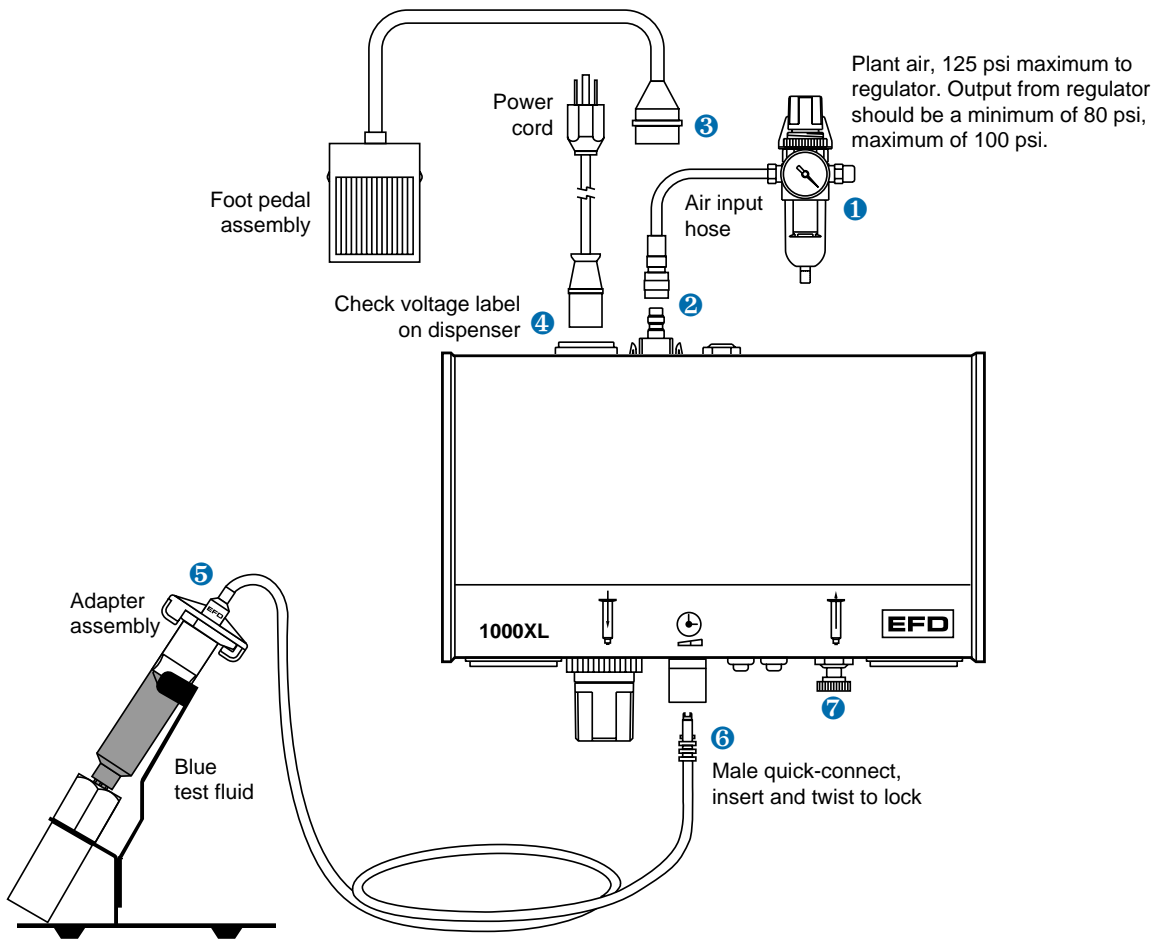

# 1000XL -- Hookup

- 1 Connect the air input hose to a plant air source. Set plant air supply within 80 to 100 psi (5.5 to 6.9 bar). Where required, use an EFD five-micron filter regulator #2000F755 (see Warranty).
- 2 Attach the air input hose coupling to the dispenser. Pull back metal ring to attach to dispenser.
- 3 Plug in the polarized foot pedal connector.
- 4 Check the voltage label on the input voltage selector cartridge. To change the voltage, remove the voltage selector from the cartridge, rotate it and position the correct voltage to show through the cartridge window. Replace the cartridge into the power cord receptacle and insure that both sides snap securely into position.  
Install the power cord.
- 5 Attach the 10cc barrel pre-filled with blue, nontoxic test fluid (included with the dispenser) to the 10cc adapter head.

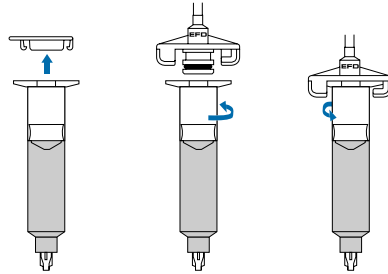

- 6 Take the 10cc adapter assembly (#5150 on the adapter head) and insert the black, male quick-connect into the air output fitting on the front panel and turn clockwise to lock. Place the barrel in the barrel stand.
- 7 During the initial testing, you will not use the vacuum control. Keep this control shut off (turned completely clockwise—do not force).

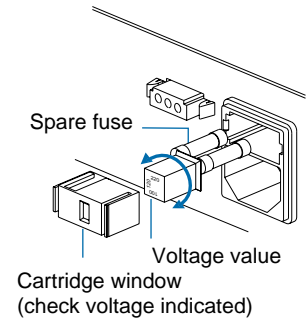

# CONTROLS and CONNECTIONS

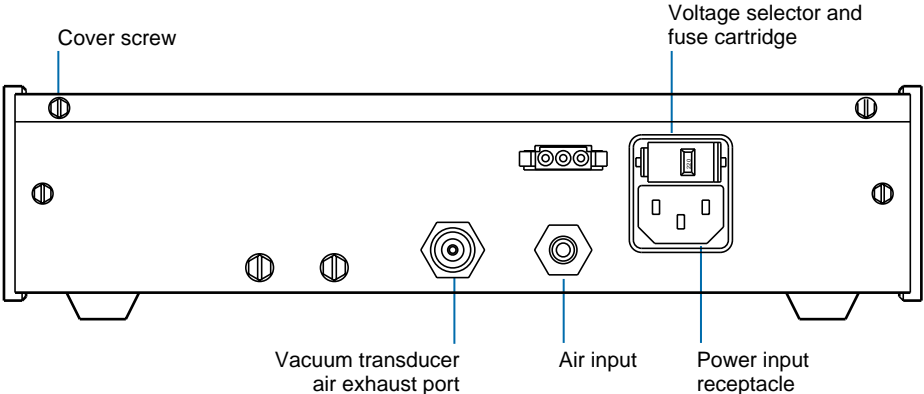
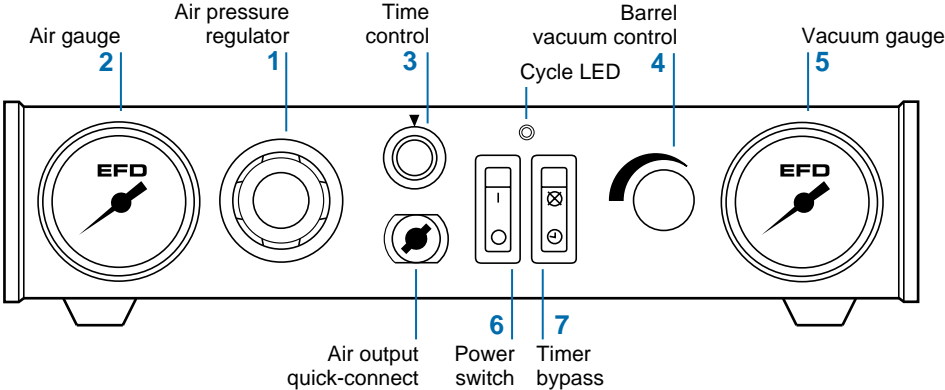



# 1000XL -- Setup for Testing

Power switch **6** should be off.

The amount of material dispensed each cycle depends on the combination of air pressure, time of air pulse, viscosity of material and dispensing tip size.

The first step is to remove the tip cap from the pre-filled barrel of blue test material (twist and pull). Replace it with an 18 gage (green) tapered dispensing tip. Press the tip on and twist clockwise to lock.

Pull out air pressure regulator knob **1** until it "clicks" into the unlocked position. Turn clockwise to adjust the air pressure to 30 psi (2.1 bar) for the initial tests.

Always set the pressure desired by turning the air regulator knob **1** clockwise. To reduce the pressure, turn the knob counterclockwise until the air gauge **2** reads a lower pressure than desired. Then increase and stop at desired pressure. Push knob in to lock.

Set the time control **3** to #7. Dispense cycle time increases from 0.01 second minimum to 1.0 second as knob is turned clockwise.

Be sure vacuum control **4** is shut off. In the initial tests, the vacuum pressure gauge **5** will indicate zero pressure. You may notice the needle on this gauge (when turned off) will jump slightly after each cycle. This is normal.

Press power switch **6** to turn on the dispenser. It will light green.

Press timer bypass switch **7**. It will light yellow. In this operation mode, the timer will be bypassed to fill the dispensing tip before you begin testing. A continuous flow of material will occur as long as the foot pedal is pressed.

Please continue to page 14 for test procedures.

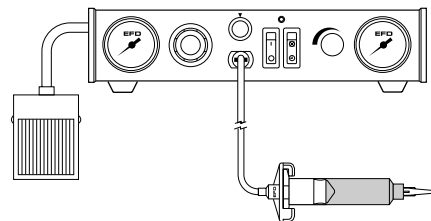

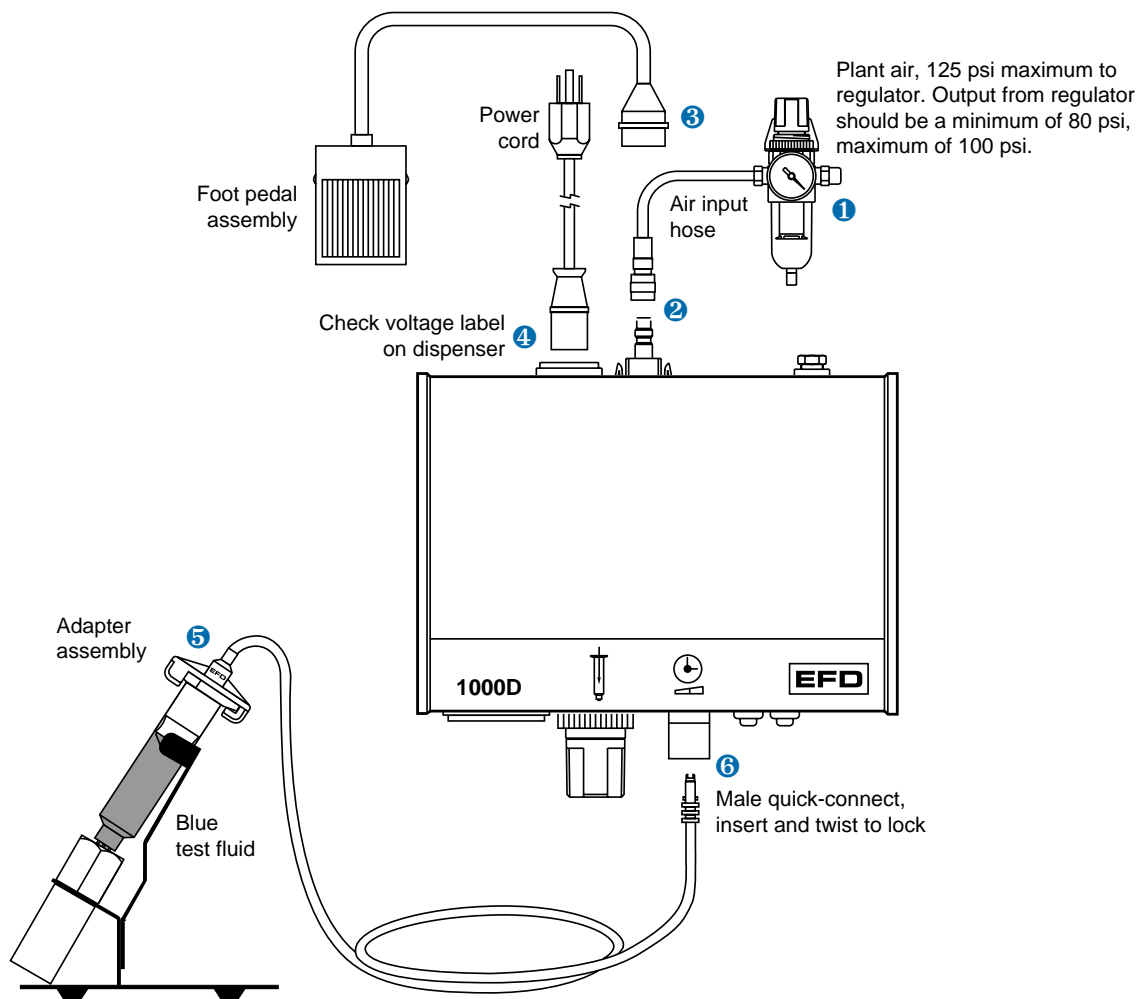

# 1000D -- Hookup

- 1 Connect the air input hose to a plant air source. Set plant air supply within 80 to 100 psi (5.5 to 6.9 bar). Where required, use an EFD five-micron filter regulator #2000F755 (see Warranty).
- 2 Attach the air input hose coupling to the dispenser. Pull back metal ring to attach to dispenser.
- 3 Plug in the polarized foot pedal connector.
- 4 Check the voltage label on the input voltage selector cartridge. To change the voltage, remove the voltage selector from the cartridge, rotate it and position the correct voltage to show through the cartridge window. Replace the cartridge into the power cord receptacle and insure that both sides snap securely into position.

Install the power cord.

- 5 Attach the 10cc barrel pre-filled with blue, nontoxic test fluid (included with the dispenser) to the 10cc adapter head.

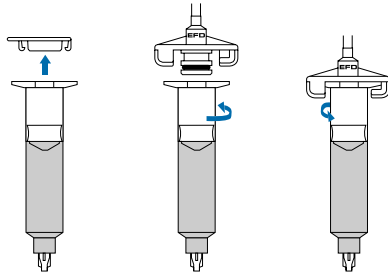

- 6 Take the 10cc adapter assembly (#5150 on the adapter head) and insert the black, male quick-connect into the air output fitting on the front panel and turn clockwise to lock. Place the barrel in the barrel stand.

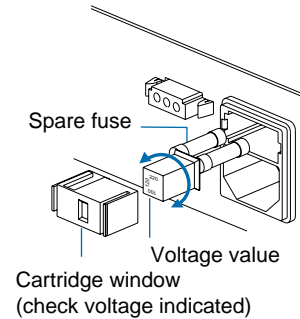

## CONTROLS and CONNECTIONS

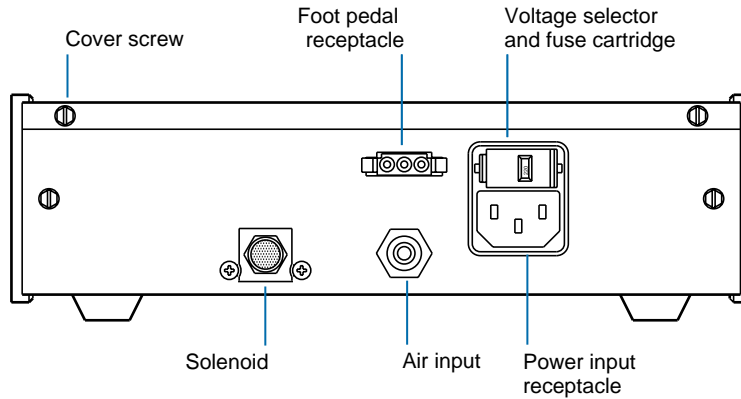
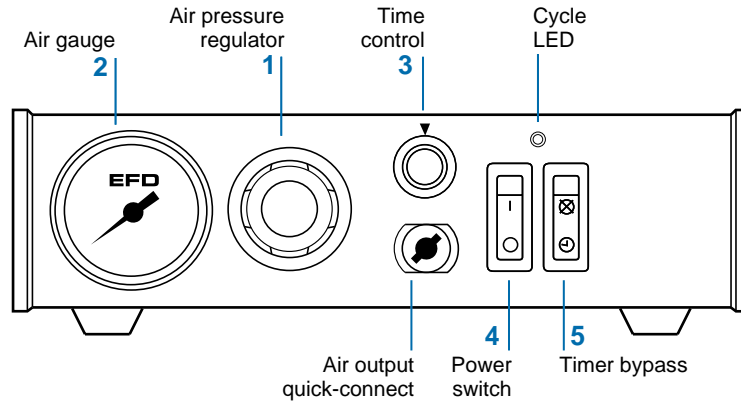

# 1000D -- Setup for Testing

Power switch **4** should be off.

The amount of material dispensed each cycle depends on the combination of air pressure, time of air pulse, viscosity of material and dispensing tip size.

The first step is to remove the tip cap from the pre-filled barrel of blue test material (twist and pull). Replace it with the 18 gage (green) tapered dispensing tip. Press the tip on and twist to lock.

Pull out air pressure regulator knob **1** until it "clicks" into the unlocked position. Turn clockwise to adjust the air pressure to 30 psi (2.1 bar) for the initial tests.

Always set the pressure desired by turning the air regulator knob **1** clockwise. To reduce the pressure, turn the knob counterclockwise until the air gauge **2** reads a lower pressure than desired. Then increase and stop at desired pressure. Push knob in to lock.

Set the time control **3** to #7. Dispense cycle time increases from 0.01 second minimum to 1.0 second as knob is turned clockwise.

Press power switch **4** to turn on the dispenser. It will light green.

Press timer bypass switch **5**. It will light yellow. In this operation mode, the timer will be bypassed to fill the dispensing tip before you begin testing. A continuous flow of material will occur as long as the foot pedal is pressed.

Please continue to page 14 for test procedures.

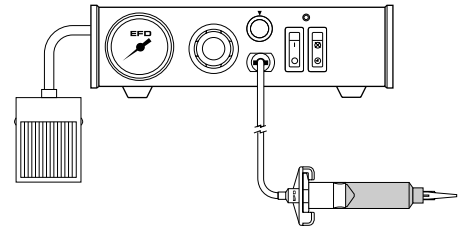

# Testing the 1000 Series Dispensers

## Making Timed Deposits

You are now ready to test the pre-filled, nontoxic, blue test fluid. This material is representative of thick, non-leveling fluids like sealants, pastes or greases.

Check your initial settings:

- A) Air gauge reads 30 psi
- B) Timer is set at #7
- C) Green tapered tip is on the test barrel
- D) Power and timer bypass switches are on.

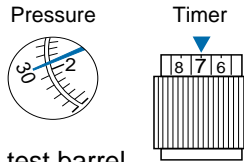

Holding the barrel as shown, rest the tip on a piece of paper. Press the foot pedal until the tip fills and some fluid is pushed out onto the paper. Repeat this whenever you change to a new tip.

With the tip filled, turn the timer bypass switch off (yellow light out).

Use the Dot Test sheet supplied, and press the foot pedal to activate the timer. Check the dot size. Press the foot pedal again and note the size consistency.

Remember—When the yellow timer bypass switch is on, a continuous flow of material will occur as long as the foot pedal is pressed. The yellow light must be off to make timed deposits.

Try different pressure settings. Continue to experiment by replacing the green tip with the blue (22 gage) tapered tip included in the Dot Test Kit. Note the effects of air pressure and tip size on the deposit.

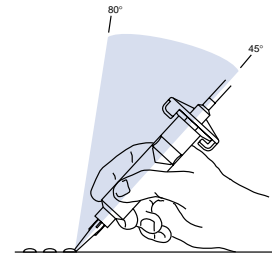

Correct angle for consistent deposits.

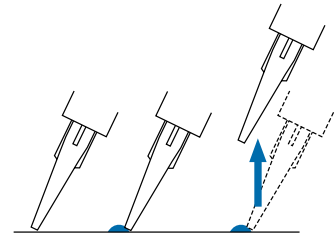





Remember - always bring the tip in contact with the work surface at the illustrated angle. After the tip is in position, press the foot pedal. Release pedal and remove tip by lifting straight up.

## Changing Deposit Size, Drawing Stripes

The dot size is determined by the tip diameter, the air pressure output setting and the pulse time. For large dots, use a large tip, higher pressure and more time. Normally, you want to use as short a time pulse as possible. To increase the dot size, slightly increase the air pressure output, or increase the tip size, or both.

Use the convenient Dot Test sheet included.





### Green Tip Settings

Test	Pressure	Time	Dot Size
A	30 psi	#7	
B	20 psi	#7	
C	20 psi	#3	
D	15 psi	#3	
E	10 psi	#3	

### Dot Test with Green Tapered Tip

First, follow the settings illustrated on the left, and you will get dots about the sizes shown. Try other times and pressures to see how easy it is to get just the dot size you want.

### Blue Tip Settings

Test	Pressure	Time	Dot Size
F	30 psi	#6	
G	20 psi	#6	
H	20 psi	#3	
I	15 psi	#3	
J	10 psi	#3	

### Dot Test with Blue Tapered Tip

These tests show the effect of using a smaller diameter tip.

Replace the green tip with the blue (22 gage) tapered tip. Now, turn on the timer bypass switch and press the foot pedal to fill the tip. Then, turn off the timer bypass switch (yellow light out) and press the foot pedal.

### Making Stripes

Keep the settings at Test G (shown to the left) and turn on the timer bypass switch (yellow light on). With the tip in contact with the test sheet, press and hold down the foot pedal while drawing a line for beading or striping.

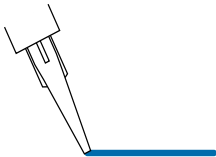



# Advanced Dispensing System

If you dispense thick fluids, several problems may occur. First, the repetitive air cycles can bore tunnels through non-leveling fluids, causing spitting and inconsistent deposits. Second, thick fluids contain trapped air that leads to drooling and oozing.

These problems are eliminated by using the SmoothFlow™ piston. That's because the white pistons prevent tunneling by providing a barrier to the pulsed-air cycles, and prevent oozing by responding to the pressure of trapped air with a slight suck-back movement after the dispense cycle.

The white piston is used for most fluids.

However, if you are applying RTV silicone and find that the piston bounces and causes stringing, switch to the orange, flat wall piston.

The SmoothFlow™ pistons make barrel filling easier, too. As you load the fluid in, air is trapped in the bottom and throughout the fluid. Simply insert a SmoothFlow™ piston and gently press down on the fluid as far as possible. This action forces out most of the air and results in consistent deposits.

## For Thick Fluids

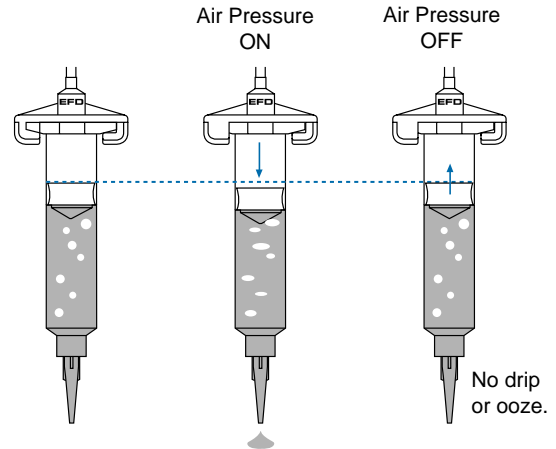



If you use low to medium viscosity fluids, the white SmoothFlow™ piston has several advantages.

First, vacuum adjustment is much less sensitive. Second, the piston prevents fumes from the fluid being exhausted into the work environment. Third, the piston prevents fluid backflow into the dispenser if the barrel is inadvertently turned upside down. Fourth, using the piston makes it easy and safe to change tips without dripping.

**Note:** If you use watery-thin fluids such as solvents, cyanoacrylates and anaerobics, specify the ULTRA System™ with the blue LV Barrier™. Available only in 10cc size.

## For Thin Fluids

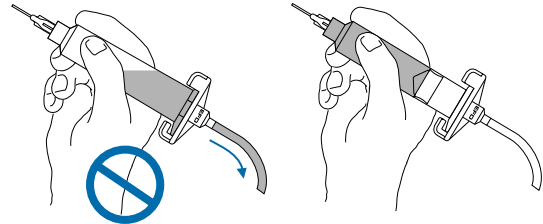

SmoothFlow™ piston prevents fluid backflow.

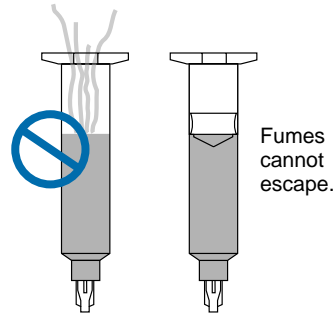

Fumes cannot escape.

## For Watery-thin Fluids

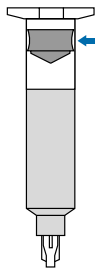

Blue LV Barrier™ for improved control of very low viscosity fluids.

Note: If you choose not to use the piston, please refer to page 19 for instructions.

# How to Use the Vacuum Control (1000XL only)

The vacuum control allows low viscosity fluids, even water, to be consistently dispensed without dripping between cycles. The vacuum exerts a negative pressure on the fluid in the barrel and prevents dripping.

For these tests, you will use the test barrel with the clear fluid.

1. While holding the barrel upright in one hand, remove the orange end cap and insert the white SmoothFlow™ piston. Carefully press the piston down to contact the liquid.

Be sure to push it far enough to remove all air, but **not** into the fluid, since this will force the fluid up along the sides of the piston.

2. Attach the barrel to the 10cc adapter. Snap the safety clip tightly closed to prevent any dripping or bubbling. Remove the tip cap and attach the 25 gage (red) tip.
3. Set air pressure at 5 psi and timer to #5, then turn on timer bypass.
4. With the barrel pointing downward over a container, press the foot pedal to fill the tip.
5. Turn off the timer bypass switch (yellow light out).
6. If a drop begins to form at the end of the tip, slowly turn the vacuum control knob counterclockwise to stop the drop from growing. Wipe the tip and slowly adjust vacuum. Normally, only 1 to 2 psi of vacuum pressure is necessary.
7. Take the barrel and place the tip on the test sheet. Press the foot pedal and release. Check the deposit. Increase or decrease by adjusting pressure or time.

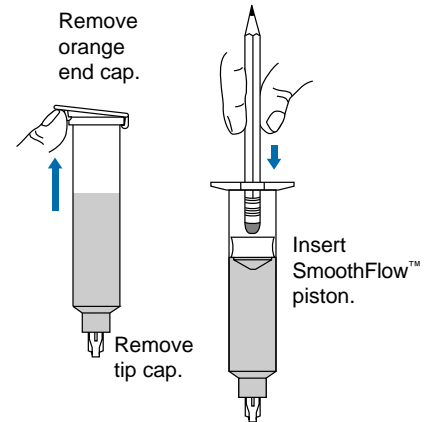

### Three things to remember

If you do not use the piston when dispensing thin fluids:

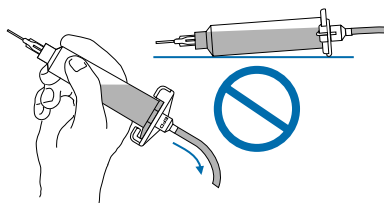

Do not tip the barrel upside down or lay flat. This will cause the liquid to run into the dispenser.

#### Open



When changing tips or attaching a tip cap, snap the safety clip completely closed to prevent any dripping or bubbling.

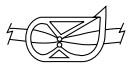

#### Closed



Use an EFD filter trap (#1000FLT-Y). This filter trap will impede the flow should the low viscosity liquid be sucked back towards the dispenser.

If you choose **not** to use the piston, please follow these instructions carefully:

1. While holding the barrel upright in one hand, twist on an orange tip cap. Using the small funnel supplied, fill about 2/3 full with your liquid.
2. Open the safety clip and attach the barrel to the 10cc adapter.
3. Close the safety clip as tight as possible.
4. Increase vacuum by turning vacuum control knob counterclockwise and set to 1.5 on the vacuum pressure gauge.
5. Then, without tipping the barrel upside down, remove the tip cap and attach the 25 gage (red) tip.
6. Open the safety clip. Your material may begin to bubble. Reduce vacuum by turning vacuum control knob clockwise.
7. If a drop begins to form at the end of the tip, slowly turn the vacuum control knob counterclockwise to stop the drop from growing. Wipe the tip and adjust vacuum as necessary.

Now the fluid is in proper balance. It does not bubble or drip.

Repeat tests as before, keeping the air pressure low and adjusting the time for different deposit sizes. Contact EFD if you have any questions.



**In the US, call 800-556-3484.**

In Mexico, call 001-800-556-3484.

In the UK, ring free 0800 585733.

# Loading the Barrel Reservoirs

**Caution:** Do not completely fill barrels. The optimum fill is a maximum 2/3 of the barrel capacity and 1/2 of the barrel capacity when using the LV Barrier™.

If the fluid you are dispensing is pourable, take the barrel, twist on a tip cap and pour your fluid in. If appropriate, insert the SmoothFlow™ piston (see page 13). Carefully press the piston down until it contacts the fluid. The barrel is now ready for use.

If you are dispensing solvents, cyanoacrylates or anaerobics, use the LV Barrier™. Place barrier in the top of the barrel reservoir. Allow air between barrier and fluid. Do not contact the barrier to the fluid.

If your fluid is thick or non-leveling, you can spoon it into the barrel with a spatula. Or, if the fluid comes packed in a 1/10 gallon cartridge, try loading the barrel with a caulking gun. Then, press in the SmoothFlow™ piston to move the fluid to the bottom of the barrel and to remove trapped air.

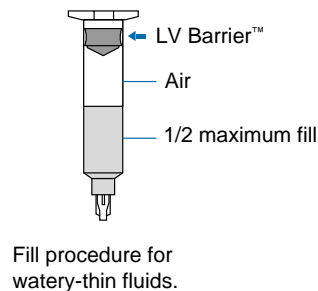
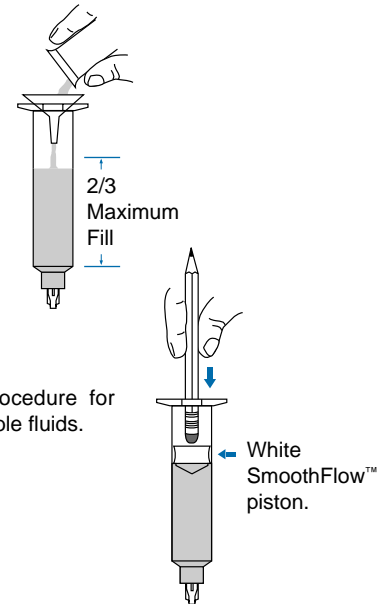
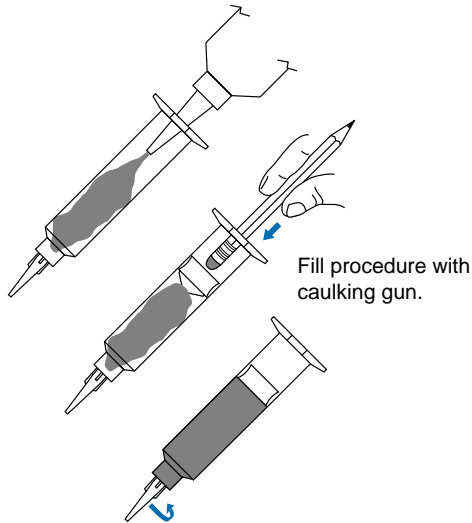

EFD offers productive alternatives to traditional barrel-loading methods. Here are a few suggestions that can help keep your work area clean, save time and reduce the chance of entrapped air in the fluid.

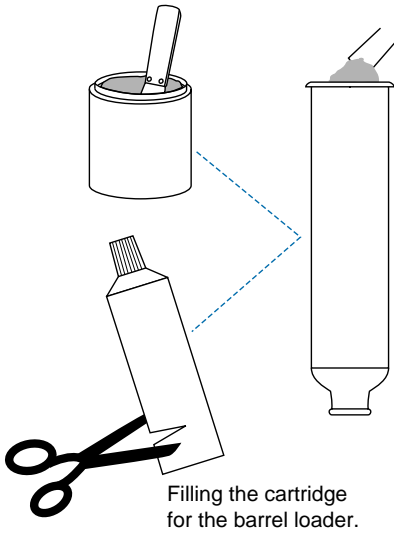

1. You could use the EFD #920BL barrel loader. Pack the fluid into the 12 ounce cartridge as shown. Then place the pre-filled cartridge into the barrel loader. Using air pressure, the barrel loader fills the barrel (with piston) from the bottom up.

If the fluid comes packed in a 1/10 gallon (300 ml.) caulk type cartridge, use the EFD #930BL barrel loader.

2. If you receive frozen epoxies or other fluids in medical type syringes with a manual plunger, request our luer-to-luer fitting #2160 to transfer the material.

Please call an EFD Product Specialist for additional assistance.

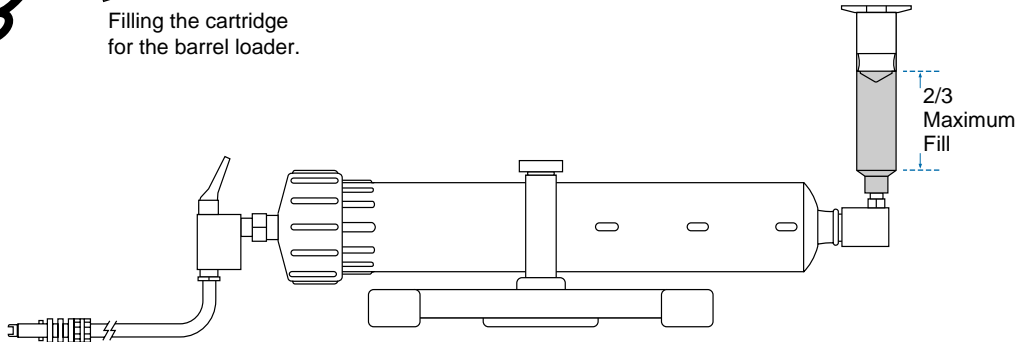

EFD #920BL Barrel Loader  
(Specify #930BL for pre-filled 1/10 gallon caulk tubes)

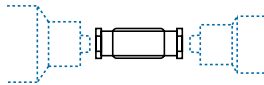

#2160 Luer-to-luer fitting

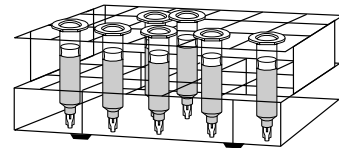

Barrel Rack  
#905BR for 3cc and 5cc barrels  
#910BR for 10cc, 30cc and 55cc barrels

# Now, test your fluid.

## Barrel Reservoir Selection

Remember, each barrel must use the proper size adapter head. Five sizes of barrels and four sizes of adapter heads (30cc and 55cc barrels use the same size adapter head) are provided with this dispenser—3cc, 5cc, 10cc, 30cc and 55cc.

The most comfortable size barrel is the 10cc. But if you plan to make very small dots, we recommend the 5cc or even the 3cc size. For large dots or encapsulating work, use the 30cc or 55cc size.

If you find you need more reservoir capacity than 55cc, consider the 2 1/2, 6 or 12 ounce cartridges. Contact EFD for assistance and specific recommendations based on your application.

## Tip Selection

The EFD 5100 Component Kit included with the dispenser contains a complete selection of disposable tips.

The appropriate tip for your application will increase assembly production. Refer to the enclosed booklet with the Component Kit for helpful recommendations.

## Time and Pressure Settings

When establishing settings for your material, keep the time as short as possible, the tip as large as possible and air pressure as needed to produce the dot size you require.

Rule of Thumb: Start with a short pulse time. Use the dispensing tip size appropriate for the size dot required. Vary air pressure. For more output, gradually increase pressure.

**Caution:** Use of high air pressure with low viscosity material and a small gage tip can expel the material some distance.



All components are quality produced in a silicone-free environment by EFD in the USA.



# Troubleshooting

## NO POWER

1. Check voltage at wall outlet.
2. Check fuse. Replace #7111E.
3. Unplug from wall, remove top cover, visually inspect for any loose or shorted connections.

## POWER, BUT NO LIGHT

1. Switch module must be replaced.

## POWER, LIGHT, BUT MACHINE DOES NOT OPERATE

1. Unplug input power cord.
2. Check foot pedal connection, foot pedal and internal switch.

## INCONSISTENT DOTS

1. Check dispensing tip, barrel and material for possible clogging.
2. Check air gauge to be sure air pressure is not varying.
3. Check to see if there are air bubbles in the material being dispensed.

## TIMER SEEMS INOPERATIVE

1. Check to be sure timer bypass switch is off (yellow light out).
2. Check DIP switch positions (see page 25).

Note: The EFD timer is very reliable. Most questions about the timer are resolved by simply turning the timer bypass switch off (yellow light out).

## MATERIAL SUCK-BACK

1. Use SmoothFlow™ pistons or LV Barriers™ to prevent this. (See pages 16-17.)
2. If it occurs, attach an empty barrel, put timer bypass switch on, put barrel in a cup and press the pedal to expel the sucked-back fluid.
3. If problem cannot be corrected, contact an EFD Product Specialist for assistance. Dispensers can be returned to EFD for repair.



If you have any problems, we will correct them immediately. Please do not hesitate to contact EFD or your authorized EFD distributor.

**In the US, call 800-556-3484.**

In Mexico, call 001-800-556-3484.

In the UK, ring free 0800 585733.

# Schematic and Parts

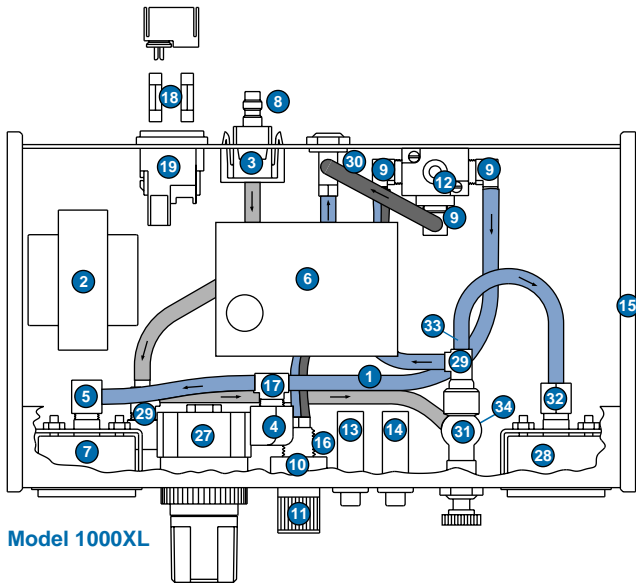

Model 1000XL

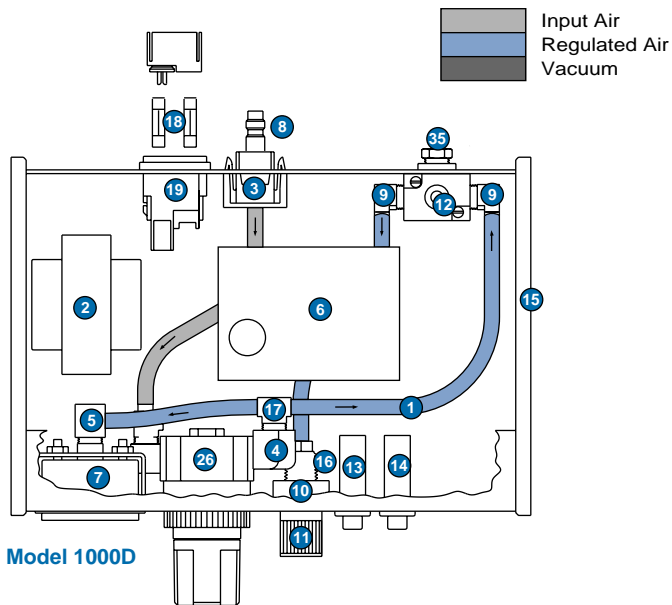

Model 1000D

## 1000D and 1000XL Replacement Parts List

- |                  |   |
|------------------|---|
| 1. 2024-160      | 1/4" OD x .160" ID tubing                             |
| 2. 2-2031-1000   | Transformer assembly multi input                      |
| 3. 2-2017A-24XL  | Foot pedal receptacle                                 |
| 4. 2169          | Fitting 1/8 NPT x 1/8 NPT elbow brass                 |
| 5. 2088          | Fitting 1/8 NPT x 1/4 barb brass                      |
| 6. 2-2006-24PR   | Programmable timer                                    |
| 7. 2001C         | 0 to 100 psi (0 to 7.0 bar) gauge                     |
| 8. 2081A         | Male mini air-coupler panel mount                     |
| 9. 2087          | Fitting 1/8 NPT x 1/4 barb elbow brass                |
| 10. 2-2007-XL    | Potentiometer assembly                                |
| 11. 2008A        | Time control knob                                     |
| 12. 2-2003-1000  | 24 VDC solenoid assembly                              |
| 13. 2010-A24     | Power switch 115 VAC                                  |
| 14. 2-2011-24    | 1000XL timer bypass switch assembly                   |
| 15. 2019         | Dispenser end panel                                   |
| 16. 2-2004B      | Quick-connect assembly                                |
| 17. 2089         | Fitting 1/8 NPT x 1/4 barb tee brass                  |
| 18. 7111E        | Fuse .160A  |
| 19. 2014XL       | Input power receptacle                                |
| 20. 2002SCR      | Replacement screen for regulator*                     |
| 21. 2009-A24     | Power cord American*                                  |
| 22. 2009-E24     | Power cord European*                                  |
| 23. 2015A        | Foot pedal assembly*                                  |
| 24. 2033         | Dispense indicator LED*                               |
| 25. 1000INP-AKIT | Air input hose*                                       |
| 26. 2-2002       | 1000D regulator assembly 0 to 100 psi (0 to 7.0 bar)  |
| 27. 2-2002-XL    | 1000XL regulator assembly 0 to 100 psi (0 to 7.0 bar) |
| 28. 2001B        | 0 to 15 psi (0 to 1.0 bar) gauge                      |
| 29. 2178         | Fitting 1/8 NPT x 1/4 barb elbow brass                |
| 30. 2-2170LV     | Vacuum transducer assembly                            |
| 31. 2-2176-XL    | Barrel vacuum control assembly                        |
| 32. 2036         | Fitting 1/8 NPT x 1/4 barb brass                      |
| 33. 2083         | Gauge restrictor                                      |
| 34. 2084         | Air restrictor  |
| 35. 7108         | 1000D muffler   |

\* Not Shown



# Programmable Timer

The heart of each 1000 Series dispenser is the EFD advanced solid-state, digital timer with programmable time ranges and choice of Momentary (press the foot pedal once) or Maintained (hold foot pedal down during time cycle) initiation modes.

This unique timer is located inside the dispenser. To access, remove the two cover screws and slide the cover off the dispenser.

**Caution:** Always disconnect the power cord before removing the cover.

The DIP switch that controls the timer has been set at the factory for a time range of 0.01 to 1.0 second, with the initiation set to MOMENTARY contact. (See top diagram.)

Experience shows this is the most often used initiation mode and time range.

For larger deposits that require longer time, it may be advantageous to set the initiation to MAINTAINED contact. The operator must then keep the foot pedal pressed throughout the time cycle.

Four time ranges are provided so that you can have fine-time adjustment in the range you select.

For extremely small dots of low viscosity, watery fluids, you may want to select the 0.005 to 0.04 second range. For slow filling, a longer time range will provide the time that's needed for flow control.

## DIP Switch Settings

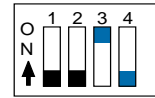

③ ON  
0.01-1.0 second  
Momentary

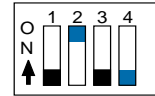

② ON  
0.1-10 seconds  
Momentary

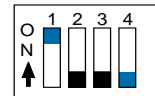

① ON  
0.2-20 seconds  
Momentary



① ② ③ ON  
0.3-31 seconds  
Momentary

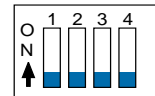

① ② ③ OFF  
0.005-0.04 second  
Momentary



② ④ ON  
0.1-10 seconds  
Maintained

④ ON = Maintained pedal contact

④ OFF = Momentary pedal contact

# Suggestions & Reminders

1. Always use an EFD SmoothFlow™ piston or LV Barrier™ to make barrel loading, dispensing and handling cleaner, safer and more accurate.

**Caution (1000XL only):** If you dispense pourable fluids and choose **not** to use SmoothFlow™ pistons, do not increase vacuum pressure rapidly and do **not** tip the barrel. Vacuum may pull liquid into the air hose; or when tipped, liquid may flow back into the dispenser.

2. Always use new barrels and tips. Carefully dispose of after use. This procedure ensures maximum cleanliness, prevents contamination and provides proper safety.
3. Do not completely fill the barrel. The optimum fill is a maximum 2/3 of the barrel capacity with the SmoothFlow™ piston and 1/2 of the barrel capacity when using the LV Barrier™.
4. Properly filtered, clean, dry plant air should be available where the dispenser is to be set up. (Bottled nitrogen can be used.) Use an EFD five-micron filter regulator #2000F755 where required.
5. Use the EFD DispenStand™ #DS1400 to help organize bench space. Adapter hose support keeps air hose off the work area.
6. Depending on the type of work you are doing, it may be easier to bring the work to the barrel. Mount the barrel on the EFD stand #7300A.
7. To ensure smooth fluid flow and consistent deposits, always have the tip at a 45° angle to the work surface.

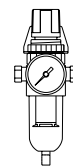

#2000F755  
Five-micron filter  
regulator

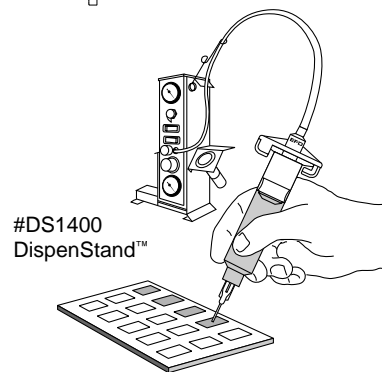

#DS1400  
DispenStand™

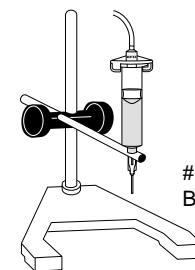

#7300A  
Barrel stand

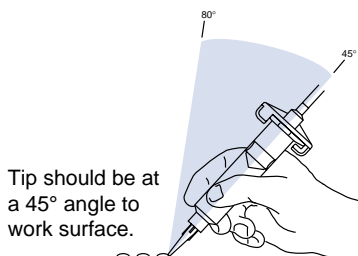

Tip should be at  
a 45° angle to  
work surface.

# ULTRA System™ Dispensing Components

For complete selection and technical details, please refer to EFD Catalog and price list.

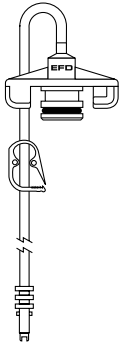

## Barrel adapter assemblies

Molded one-piece, yellow, SnapLok™ adapter head with Buna N O-ring, flexible 5/32" OD hose, male quick-connect and safety clip.

size	with 3-ft hose	with 6-ft hose
3cc	1000Y5148	1000Y5148-6
5cc	1000Y5149	1000Y5149-6
10cc	1000Y5150	1000Y5150-6
30cc/55cc	1000Y5152	1000Y5152-6

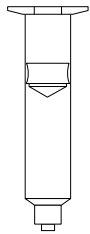

## ULTRA System™ barrels/pistons

Industrial-grade ZeroDraft™ barrels and white SmoothFlow™ pistons are molded silicone-free by EFD. Each box contains the same quantity of ZeroDraft™ barrels and white SmoothFlow™ pistons.

size	clear	UV-block	light-block	sets/ box
		amber	black	
3cc	5109CP-B	5109AP-B	5109UP-B	50
5cc	5110CP-B	5110AP-B	5110UP-B	40
10cc	5111CP-B	5111AP-B	5111UP-B	30
30cc	5112CP-B	5112AP-B	5112UP-B	20
55cc	5113CP-B	5113AP-B	n/a	15

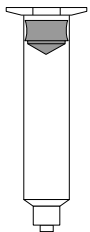

## LV Barrier™ ULTRA System

Designed specifically for dispensing low viscosity fluids including solvents, cyanoacrylates and anaerobics. Each box contains the same quantity of ZeroDraft™ barrels and blue LV Barriers™.

size	clear	sets/box
10cc	5111LV-B	30

## Smooth-flow tapered tips

Molded polyethylene with UV block. Packaged (50) tips per see-through box with covers for easy part identification.

gage	ID	tapered	color
14	.063"	5114TT-B	olive
16	.047"	5116TT-B	grey
18	.033"	5118TT-B	green
20	.023"	5120TT-B	pink
22	.016"	5122TT-B	blue
25	.010"	5125TT-B	red



## General-purpose precision tips

All EFD dispensing tips incorporate the unique SafetyLok™ color-coded polypropylene hubs. Packaged (50) tips per see-through box for easy part identification.

gage	ID	1/2" length	hub color
14	.061"	5114-B	olive
15	.054"	5115-B	amber
18	.033"	5118-B	green
20	.024"	5120-B	pink
21	.020"	5121-B	purple
22	.016"	5122-B	blue
23	.013"	5123-B	orange
25	.010"	5125-B	red
27	.008"	5127-B	clear
30	.006"	5130-B	lavender

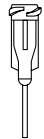

## EFD Ten Year No-fault Warranty

All components of EFD dispensers are warranted to the original end user for ten years from date of purchase.

Within the period of this warranty, EFD will repair or replace free of charge any defective component, regardless of fault, on return of the part, or the complete dispenser, prepaid to the factory.

In no event shall any liability or obligation of EFD arising from this warranty exceed the purchase price of the equipment. Before using, user shall determine the suitability of the product for his intended use, and user assumes all risk and liability whatsoever in connection therewith. This warranty is valid only when clean, dry, filtered air is used.

**EFD makes no warranty whatsoever of merchantability or fitness for a particular purpose. In no event shall EFD be liable for incidental or consequential damages.**



*Headquarters:* 977 Waterman Avenue, East Providence, RI 02914-1378 USA  
Toll free: 800-556-3484 Mexico: 001-800-556-3484  
Telephone: +1-401-434-1680 Fax: +1-401-431-0237  
e-mail: [technical@efd-inc.com](mailto:technical@efd-inc.com) [www.efd-inc.com](http://www.efd-inc.com)

Sales and service of EFD dispensers and dispensing components is available through EFD authorized distributors in over 30 countries. Please contact EFD U.S.A. for specific names and addresses.

Unit 14, Apex Business Centre, Boscombe Road  
Dunstable, Bedfordshire LU5 4SB UK  
Telephone: (0) 1582 666334 Fax: (0) 1582 664227  
Freephone: 0800 585733 From Ireland: 00800 8272 9444  
e-mail: [uk@efd-inc.com](mailto:uk@efd-inc.com)



Printed on  
recycled paper